

# Directions For Installing No. 327 STANLEY PIVOT HINGE

The Stanley No. 327 Pivot Hinge can be used for overlay type installations.

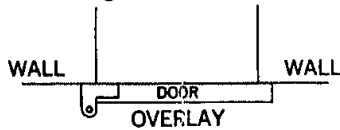

The instructions given are for an overlay installation using a No. 327 Pivot Hinge set mounted right handed. The No. 327 is reversible (not handed). Left hand installation is opposite.

2

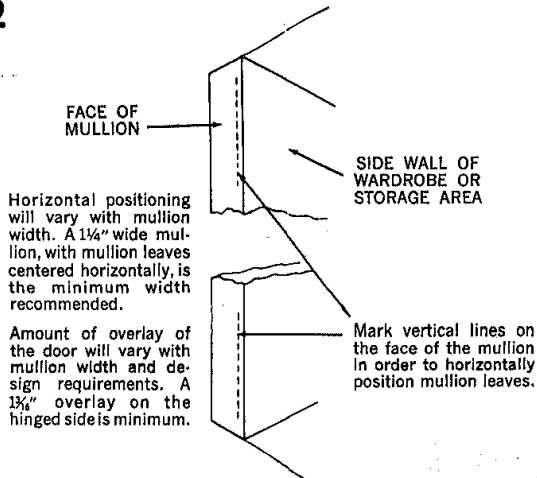

3

Mortise as shown on top and bottom of door if minimum vertical clearance is desired.

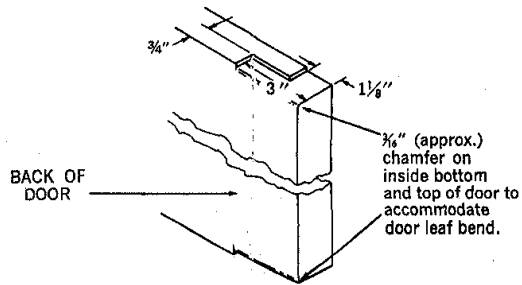

NOTE: Mortising may be eliminated if approximately 1/2" clearance at top & bottom is acceptable.

4

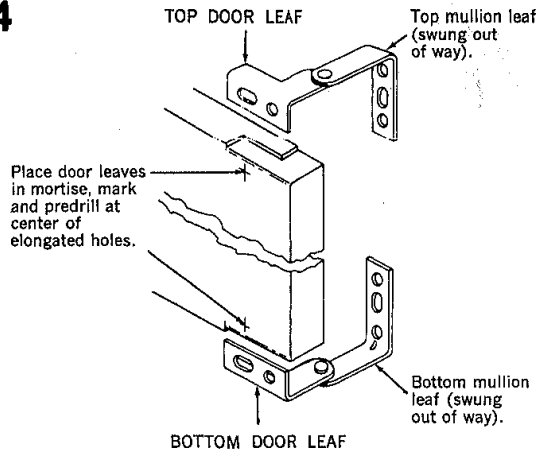

5

To allow for vertical adjustment and sufficient clearance under the door, the bottom mullion leaf should be mounted at least 1/4" off the floor. If carpet or other special floor coverings are used, additional clearance should be allowed equal to their thickness.

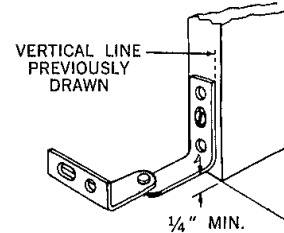

Apply bottom hinge to face of mullion using the center of the elongated hole. Be sure to line up with previously drawn vertical line.

6

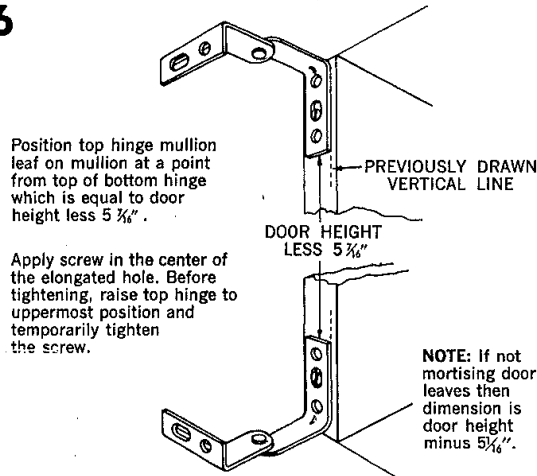

7

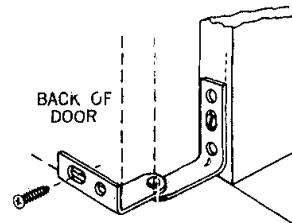

Open bottom door leaf to 180° position.

Locate bottom door mortise on bottom hinge door leaf.

Apply screws through elongated hole into predrilled hole.

In the same way, locate top door mortise on top hinge door leaf by dropping top jamb leaf. Apply screw into predrilled hole.

8

Make final door alignment if necessary by tapping leaves that have elongated holes. If substantial horizontal adjustment is necessary, additional mortising of the door may be required.

Apply remaining screws. Tighten all remaining screws to complete the installation.