

# HOW TO INSTALL

# STANLEY® SERIES BF50 Folding Door Hardware

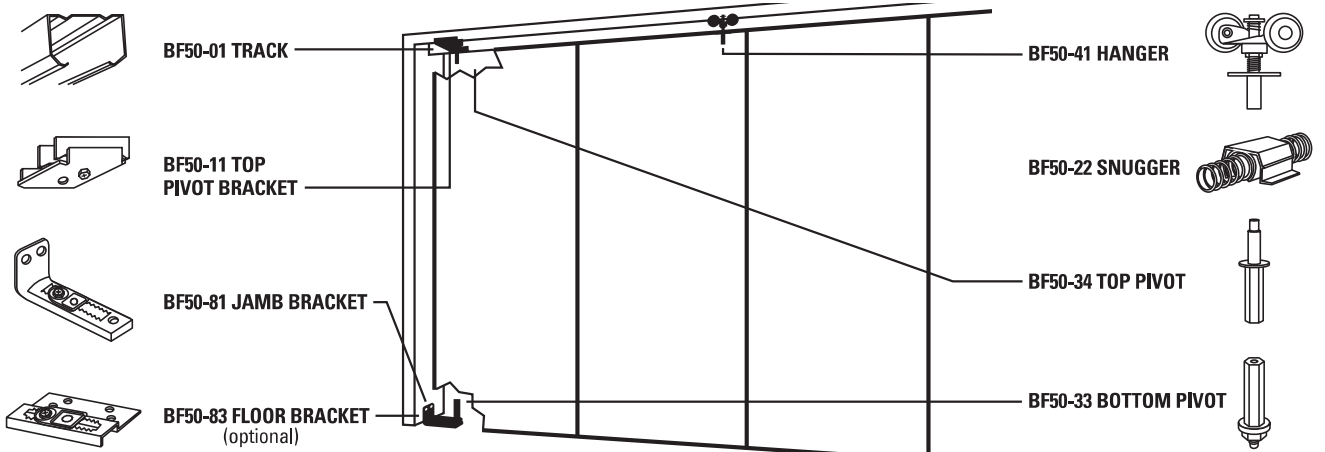

## FOR 2 OR 4 DOOR INSTALLATIONS

UP TO 50 LBS. Ea (max. two doors to a jamb)

**STEP 1 - DOOR HEIGHT** - make  $2\frac{1}{4}$ " less than finished opening height. (Allow added clearance for carpeting thickness.)

**STEP 2 - DOOR WIDTH** - subtract the following from net opening width and divide by number of doors;

DOOR SIZE	TRIM SIZE	TWO DR. OPENING folds to one side	FOUR DR. OPENING folds to two sides
*1" to $1\frac{3}{8}$ "	$\frac{3}{4}$ "	$\frac{3}{4}$ "	$1\frac{1}{4}$ "
1" to $1\frac{3}{8}$ "	$\frac{3}{8}$ "	$\frac{1}{2}$ "	$\frac{3}{4}$ "
1"	without	$\frac{1}{4}$ "	$\frac{1}{2}$ "
$1\frac{3}{8}$ "	without	$\frac{3}{8}$ "	$\frac{5}{8}$ "

\*Ex: 30" less  $\frac{3}{4}$ " equals  $29\frac{1}{4}$ " divided by 2 or  $14\frac{5}{8}$ " each door.  
Above dimensions do not allow for paint thickness!

### TWO DOOR INSTALLATION

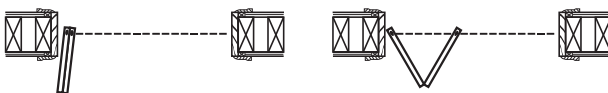

### FOUR DOOR INSTALLATION

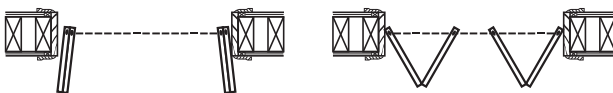

**STEP 3 - Drill holes  $\frac{7}{16}$ " dia. x  $1\frac{1}{2}$ " (min.) deep, the distance from edge of doors shown, (A) tap top and bottom pivots into holes with light hammer blows, (B) Screw hanger T-nut in position and turn hanger into T-nut as far as possible. (Crimp in T-nut acts as lock nut.)**

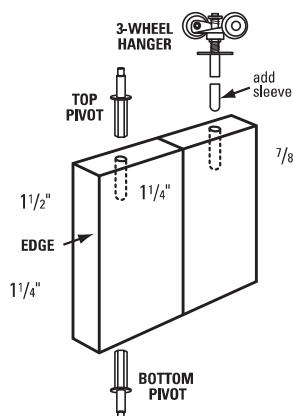

## FOR ACCORDION DOOR INSTALLATIONS

UP TO 30 LBS. Ea (more than two doors to a jamb)

**STEP 1 - DOOR HEIGHT** - make  $2\frac{1}{4}$ " less than finished opening height. (Allow added clearance for carpeting thickness.)

**STEP 2 - DOOR WIDTH -**

**EDGE HUNG TO ONE JAMB** - Any EVEN number of same size doors may be used, providing hangers are placed on every other door.

From net opening width subtract the total of  $\frac{3}{8}$ " for first pair of doors plus  $\frac{1}{16}$ " for each additional pair of doors. Then divide by total number of doors.



Ex: 10 doors in 120" net opening -  
 $\frac{3}{8}$ " plus  $\frac{1}{4}$ " ( $\frac{1}{16}$ " x 4 pr.) =  $\frac{5}{8}$ ".  $120" - \frac{5}{8}" = 119\frac{3}{8}" \div 10$   
or  $11\frac{15}{16}"$  each door.

**EDGE HUNG TO BOTH JAMBS** - Figure (as above) to each jamb separately using one half OVERALL net opening width.

**CENTER HUNG TO ONE JAMB** - One HALF door required with ANY number of full size doors, providing hangers are placed on every door starting at lead or center door.



Ex:  $9\frac{1}{2}$  doors (9 full and 1 half) in 120" net opening -  
(1) FOR FULL SIZE DOORS: From net opening width subtract total of  $\frac{15}{8}$ " for first pair plus  $\frac{1}{16}$ " for each additional pair, then divide by total number of doors.  
 $\frac{15}{8}$ " plus  $\frac{1}{4}$ " ( $\frac{1}{16}$ " x 4 pr.) =  $\frac{17}{8}$ ".  $120" - \frac{17}{8}" = 118\frac{1}{8}" \div 9\frac{1}{2}$  or  $12\frac{7}{16}"$  each full door.  
(2) FOR HALF DOOR: Take  $\frac{1}{2}$ " of full door plus  $\frac{1}{4}$ ".  
 $\frac{12\frac{7}{16}" \div 2 = 6\frac{7}{32}" + \frac{1}{4}" = 7\frac{15}{32}"$ .

**CENTER HUNG TO BOTH JAMBS** - Figure to each jamb separately using one half OVERALL net opening width.

**STEP 3** - Drill pivot and T-nut holes same as Step 3 left hand column, except that all holes should be  $1\frac{1}{4}$ " from door edge in accordion installations (more than two doors to a jamb).

**2 OR 4 DOOR INSTALLATIONS - continued**

**STEP 4 -** Install hinges.

**STEP 5 -** Trim track to exact length of finished opening, and screw track to header. Loosen top pivot bracket to adjust, making certain hex screw is closest to jamb.

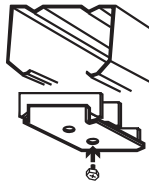

**STEP 6 -** Attach jamb pivot bracket to center line of pivot hole is plumb with center line of track. Bottom leg should rest firmly on carpet or floor. (Hole is provided for mounting to floor if desired.)

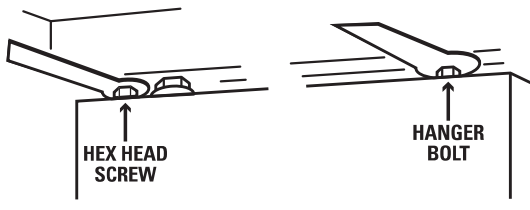
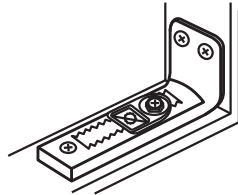

**STEP 7 - TO ADJUST DOORS HORIZONTALLY -** with wrench provided, loosen hex head screw on jamb bracket, or top pivot bracket as required. **TO ADJUST VERTICALLY -** place large end of wrench on bottom pivot hex nut and make a series of short ratchet-like turns. (Min. clearance between top of door and track is 1/4".) Finally, adjust hanger bolt for smooth, even "ride" in track.

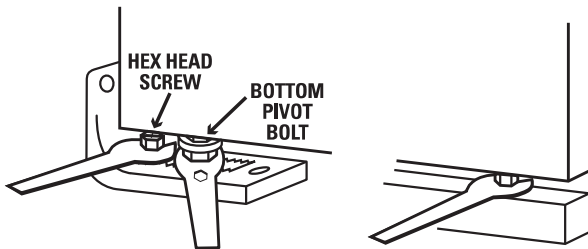

**STEP 8 -** Press snigger into track between sets of doors (or door and jamb in 2 Dr. installation). Snigger is self-centering along track.

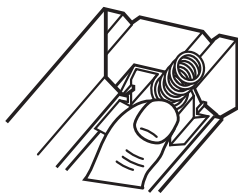

Step 8 continued on next page

**ACCORDION DOOR INSTALLATIONS - continued**

**STEP 4 -** Install mortise hinges with knuckles alternately at front and rear of doors, then separate hinges by pulling pins. Keep knuckles close to door edge.

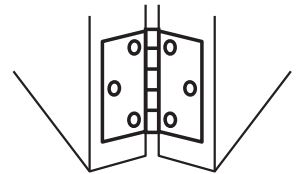

**STEP 5 -** Trim track (same as Step 5, left hand column).

**STEP 6 -** With edge hung doors, when locating close to a wall, drop ceiling, post, etc., minimum clearance to track should be (X); thickness of door plus 1".

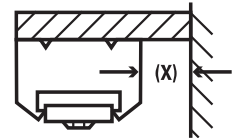

**STEP 7 -** Attach jamb pivot bracket (same as Step 6, left hand column).

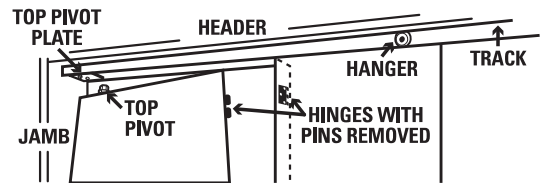

**STEP 8 -** Lift door with pivot into position by inserting spring-loaded pivot pin into top pivot bracket. Push door upward (compressing pin), then drop bottom pivot into jamb bracket hole. With other doors, enter hangers on track where ridges are notched out. Slide doors together and reassemble hinges by replacing pins.

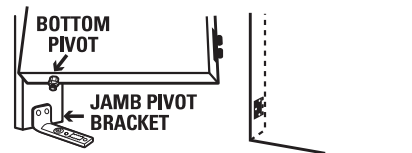

**STEP 8 (expanded) -**

**A -** Find cut-outs in track.

**B -** Rotate hanger to fit wheels in track from below the cut-outs.

**C -** Rotate hanger to align wheels to track.

**D -** Adjust so spring slightly compresses.

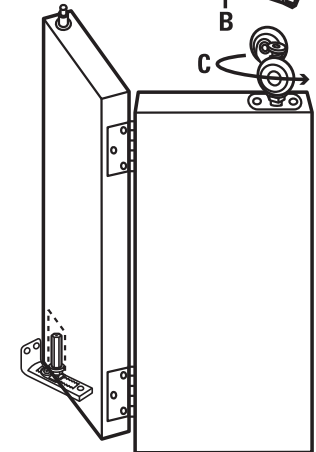
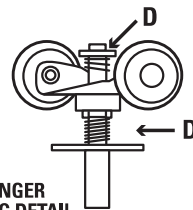
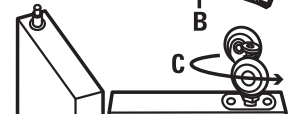
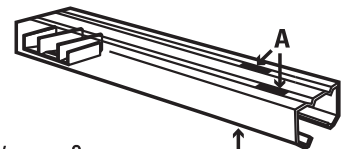

HANGER SPRING DETAIL

**2 OR 4 DOOR INSTALLATIONS** - continued

**STEP 8** (expanded) -

**A** - Find cut-outs in track.

**B** - Rotate hanger to fit wheels in track from below the cut-outs.

**C** - Rotate hanger to align wheels to track.

**D** - Adjust so spring slightly compresses.

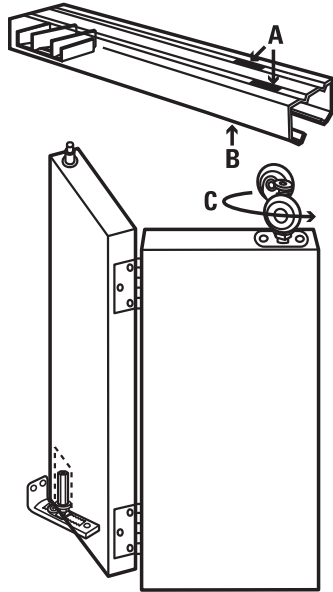
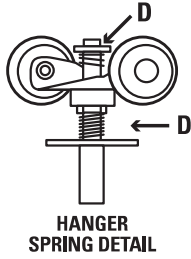

**ACCORDION DOOR INSTALLATIONS** - continued

**STEP 9** - To adjust doors horizontally and vertically (same as Step 7, left hand column).

**STEP 10** - Insert snugger (same as Step 8, left hand column. Where doors are mounted to both jambs, use two between lead or center doors.

**STEP 11** - (OPTIONAL) For openings over 8' wide, where edge hung doors are mounted. Install in bottom of door same as for hanger, or 1 1/4" from door edge. (Use one below each hanger.) Mortise guide channel into floor 5/8" for full concealment.

