

# Installation Instructions for 7KC 1DT & 9K 1DT & 2DT Dummy Trim Assemblies

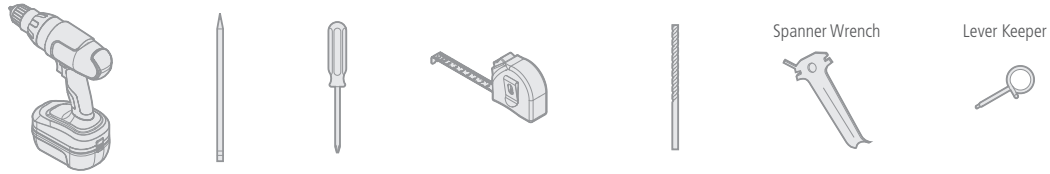

dormakaba Group

## Tools Needed



**1** For 9K Dummy Trim: Disassemble Dummy Trim: Disengage the lever by pushing the pointed end of the spanner wrench into the hole on the lever. Slide the lever off.

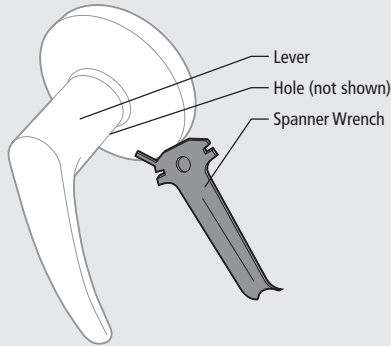

**!** For 9K double dummy trim, disassemble the inside trim assembly only. There is no need to disassemble the outside trim.

Unscrew the rose from the sleeve. Using a spanner wrench, pry the rose from the liner.

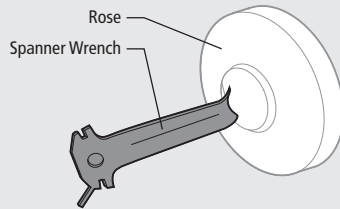

**For 7KC Dummy Trim:** Disassemble Dummy Trim: Disengage the lever by pushing the lever keeper tool into the hole on the lever and sliding the lever off of the sleeve.

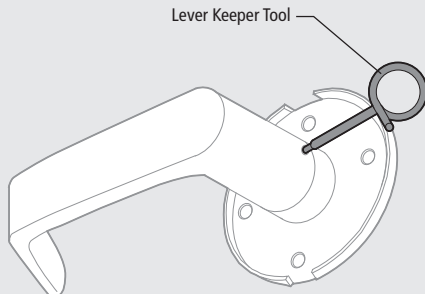

**2** Mark and Drill Holes: Draw a height line across the face of the door. The suggested height is 40-5/16" from the finished floor.

**!** For pairs of doors, install the dummy trim at the same height and backset distance from the edge of the door to the center of the lock trim on both the active and inactive doors.

**For 9K Dummy Trim:** Place K18 template on door or use mounting plate holes. Mark and drill the two holes halfway through door for single dummy trim for #8 x 1" screws.

For double dummy trim, drill two holes completely through door using a 9/32" drill bit per K18 template.

**For 7KC Dummy Trim:** Place T56063 template on door or use liner and sleeve assembly to mark top and bottom holes.

For single dummy trim, drill these two holes halfway through door for #8 x 1" screws.

For double dummy trim, on opposite side of door drill left & right pilot holes halfway through door for #8 x 1" screws.

**3** For 9K Single Dummy Trim: Install Dummy Trim: Fasten the sleeve onto the door with the screws provided.

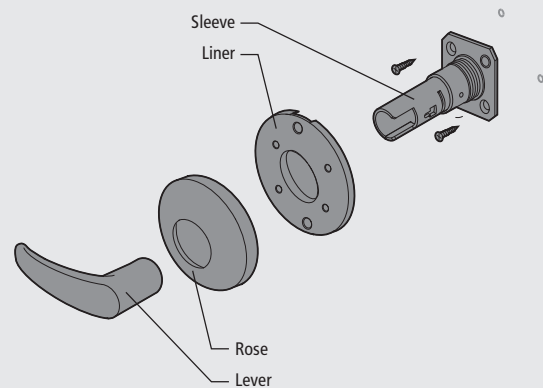

Thread on the liner until it seats against the door.

**!** Slide the liner onto the sleeve in the opposite way from the normal installation.

Press the rose over the liner until it fits flush against the door.

Press on the lever.

**For 9K Double Dummy Trim:** Install the outside trim assembly with studs on the outside of the door.

Align the inside sleeve and secure using the screws provided.

Thread on the inside liner until it seats against the door.

 Slide the liner onto the sleeve in the opposite way from the normal installation.

Press on the rose over the liner assembly.

Press on the inside lever.

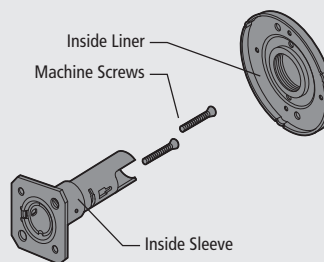
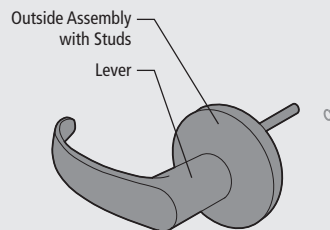

**For 7KC Single Dummy Trim:** Fasten the liner and sleeve assembly onto the door with the screws provided.

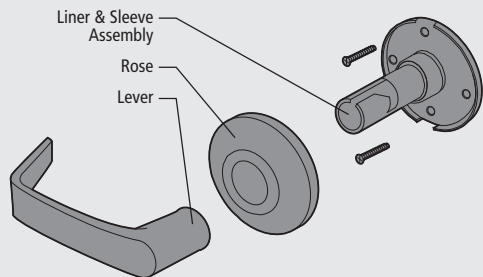

Press the rose over the liner until it fits flush against the door.

Press on the lever.

For assistance or warranty information:  
Call 1-800-392-5209 or visit  
<https://dhwsupport.dormakaba.com/hc/en-us>

Si desea ayuda o información sobre la garantía:  
llame al 1-800-392-5209 o visite  
<https://dhwsupport.dormakaba.com/hc/en-us>

Pour de l'aide ou des informations sur la garantie:  
Veuillez appeler le 1-800-392-5209 ou visiter  
<https://dhwsupport.dormakaba.com/hc/en-us>

 **Warning:** This Manufacturer advises that no lock can provide complete security by itself. This lock may be defeated by forcible or technical means, or evaded by entry elsewhere on the property. No lock can substitute for caution, awareness of your environment, and common sense. Builder's hardware is available in multiple performance grades to suit the application. In order to enhance security and reduce risk, you should consult a qualified locksmith or other security professional.

 **Advertencia:** Este fabricante hace saber que no hay cerraduras que puedan proporcionar seguridad completa por sí mismas. Esta cerradura puede fallar forzándola o utilizando medios técnicos o entrando por otra parte del edificio. No hay cerraduras que puedan sustituir precaución, estar al tanto de su entorno y sentido común. Este fabricante también ofrece cerraduras de diferentes grados y rendimientos para ajustarse a su aplicación. Para mejorar la seguridad y reducir riesgos, usted debe consultar con un cerrajero especializado u otro profesional de seguridad.

 **Advertissement:** Le fabricant tient à vous aviser qu'aucun verrou ne peut à lui seul offrir une sécurité complète. Ce verrou peut être mis hors d'état par la force ou des moyens techniques ou être évité par l'utilisation d'une autre entrée sur la propriété. Aucun verrou ne peut remplacer la surveillance de votre environnement et le bon sens. La quincaillerie pour le constructeur est offerte selon différents grades de performance pour différentes applications. Afin d'augmenter la sécurité et de réduire le risque, vous devriez consulter un serrurier qualifié ou un autre professionnel de la sécurité.