

662HD - (CE-12R) 12 WIRE EASY ACCESS WITH REMOVABLE OPTION

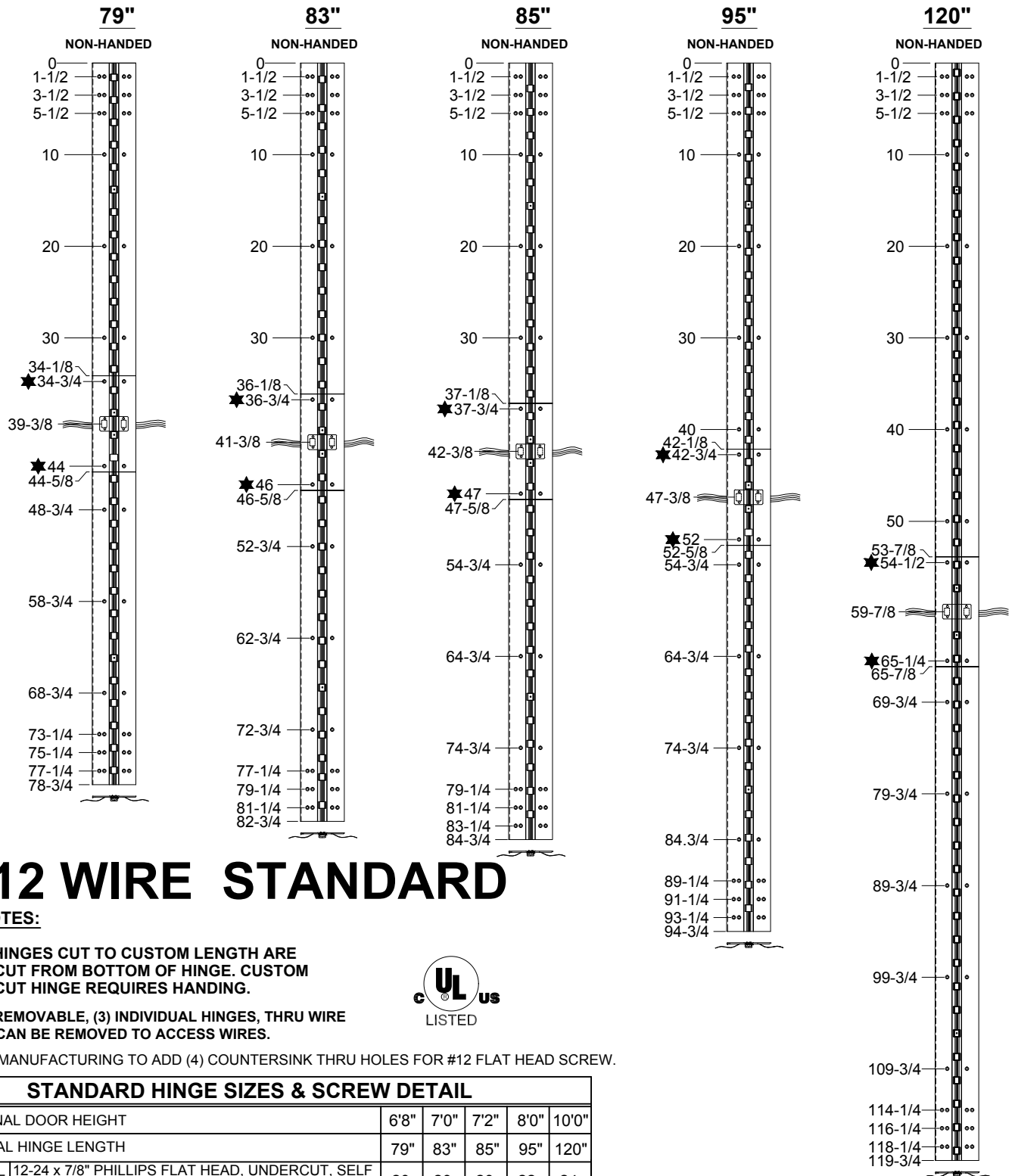

12 WIRE STANDARD

NOTES:

1. HINGES CUT TO CUSTOM LENGTH ARE CUT FROM BOTTOM OF HINGE. CUSTOM CUT HINGE REQUIRES HANDING.

R = REMOVABLE, (3) INDIVIDUAL HINGES, THRU WIRE CAN BE REMOVED TO ACCESS WIRES.

★ = MANUFACTURING TO ADD (4) COUNTERSINK THRU HOLES FOR #12 FLAT HEAD SCREW.



STANDARD HINGE SIZES & SCREW DETAIL

NOMINAL DOOR HEIGHT		6'8"	7'0"	7'2"	8'0"	10'0"
ACTUAL HINGE LENGTH		79"	83"	85"	95"	120"
FRAME	12-24 x 7/8" PHILLIPS FLAT HEAD, UNDERCUT, SELF DRILLING, THREAD FORMING TEK MACHINE SCREW	20	20	20	22	24
DOOR	12-24 x 7/8" PHILLIPS FLAT HEAD, UNDERCUT, SELF DRILLING, THREAD FORMING TEK MACHINE SCREW	20	20	20	22	24



662HD - (CE-12R) 12 WIRE EASY ACCESS WITH REMOVABLE OPTION

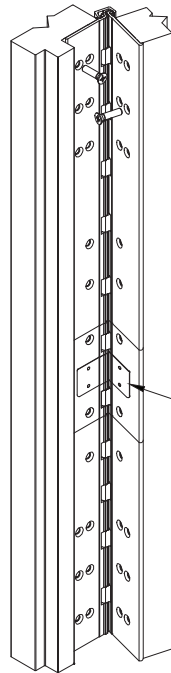
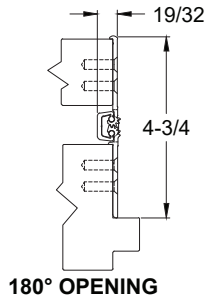
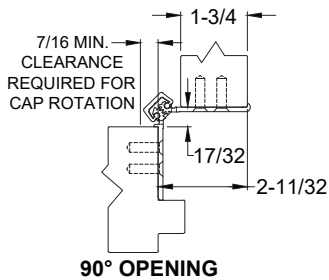
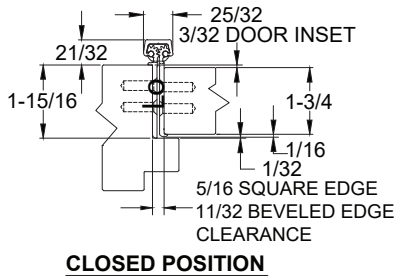
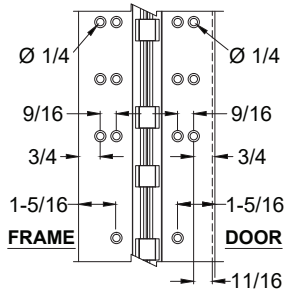

#6 SPANNER FLAT HEAD
 SECURITY SCREW PROVIDED
 STANDARD (4 PLACES)

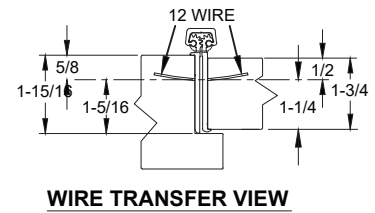
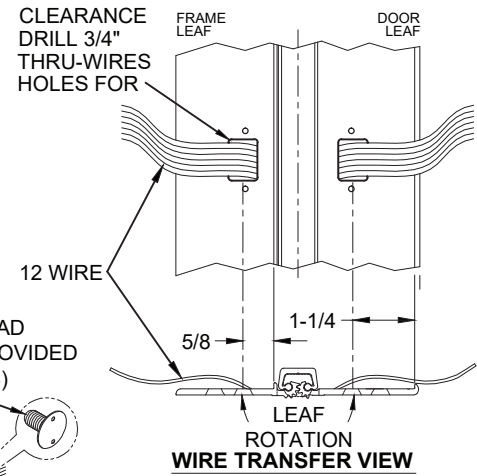
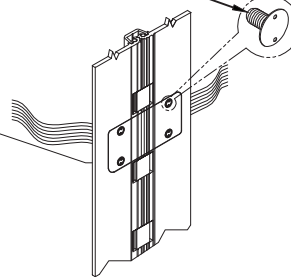

SPECIFICATION:

DESCRIPTION: SINGLE CONDUCTOR #22 AWG WIRE FOR APPLICATIONS REQUIRING EXTREME FLEXIBILITY.

CONDUCTOR: #22 AWG 168/44 (0.002") SOFT BARE COPPER LHL.

INSULATION: PROPRIETARY FORMULATION PVC 0.010" NOM. WALL MEETS VW-1 FLAME REQUIREMENT.

DIAMETER: 0.053" ± 0.003".

RESISTANCE: 16.7 OHMS MAX. @ 20°C, PER 1000 FT.

VOLTAGE RATING: 600 VOLTS RMS, DEPENDING ON SPECIFICATION.

AVAILABLE AS RoHS COMPLIANT.

