

Packing List

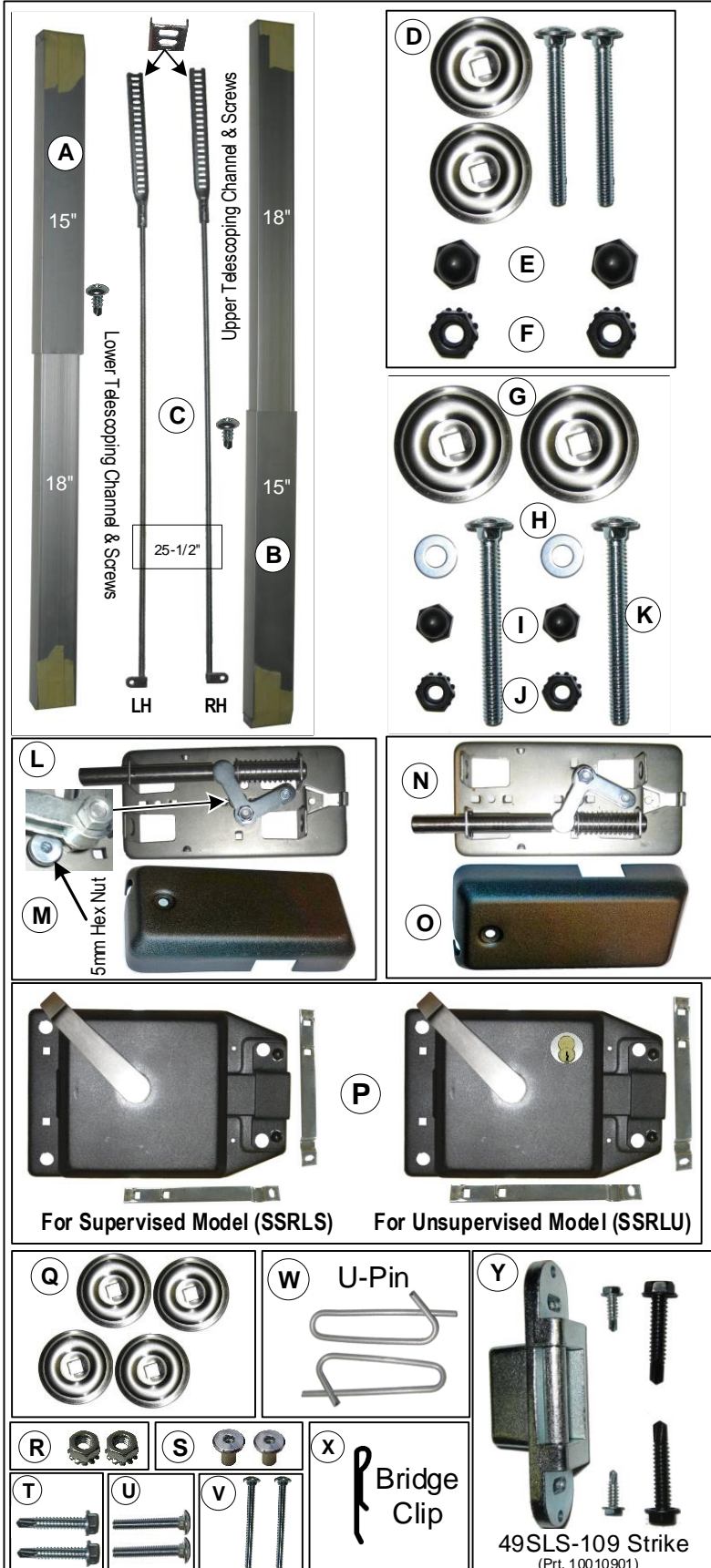

QTY.	ITEM
(A) 1	Top Telescoping Channel w/ self drilling screw
(B) 1	Bottom Telescoping Channel w/ self drilling screw
(C) 1	Top and Bottom Rod with connecting arm set – 25-1/2"
(D) 2	1/4" - 20 x 2 – 3/4" Carriage Bolts w/ stamped washers
(E) 2	1/4" - 20 Acom Cap Nuts
(F) 2	1/4" - 20 K – Lock Nuts
(G) 2	Stamped Washers
(H) 2	1/4" Flat Washers
(I) 2	1/4" - 20 Acom Cap Nuts
(J) 2	1/4" - 20 K – Lock Nuts
(K) 2	1/4" - 20 x 2 – 1/2" Carriage Bolts
(L) 1	Upper Module w/ 5mm Hex Nut
(M) 1	Special Top Module Cover w/ Plastic cap
(N) 1	Lower Module w/ 5mm Hex Nut
(O) 1	Special Lower Module Cover w/ Plastic cap
(P) 1	Main Lock Body w/ (2) Rod Holders
(Q) 4	Stamped Washers
(R) 2	1/4" - 20 K – Lock Nuts
(S) 2	1/4" - 20 5mm Hex Nuts
(T) 2	#14 x 1- 1/2 Hex head washer self drilling screws
(U) 2	1/4" - 20 x 1 – 3/4" Carriage Bolts
(V) 2	1/4" - 20 x 3 – 1/4" Carriage Bolts
(W) 2	U-Pins
(X) 2	Bridge Clips
(Y) 1	49SLS-109 Strike- #14 x 1-1/2" TEK HWH Screws and #8 x 5/8 TEK HWH screws
(Z) 1	Cardboard template

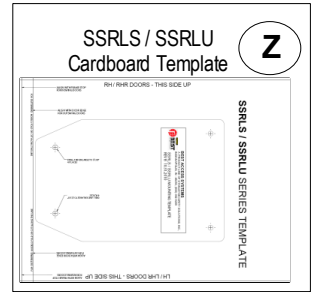

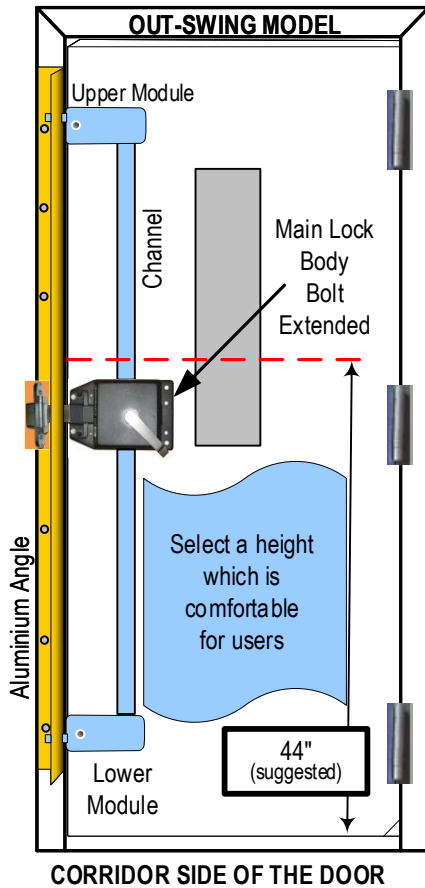

CORRIDOR SIDE OF THE DOOR

The locksets are handed. When unlocked, the lever should always point upward at a 45° angle.

3- Point Horizontal Lock Installation

DOOR MARKING & DRILLING:

IMPORTANT: Make sure the door swings free and smooth before you begin the installation. Remove all old locks, exit devices, any slide bolts or other hardware & brackets. Make sure any exposed holes left from previous hardware are completely covered after installation.

Make any adjustments to make the door swing FREELY before you start marking and installing.

- 1) **A** Mark a horizontal reference line on the corridor side of the door, at a height of 44" from the bottom of the door (not floor). Extend the line to the hinge side of the door.
- 2) **B** Line up the template with the horizontal reference line and the door edge then tape it to the door. Please refer the cardboard template to mark and drill the holes. Drill (4) 3/8" through holes (TIP: Start with 1/8"). Make sure you drill level.
- 3) **C** Select a location for the height of the top module (suggested at a height of 25-1/8" from the horizontal reference line). Mark a horizontal line approx. 12" from the lock edge of the door. Make sure the line is level.
- 4) **D** Select a location for the height of the bottom module (suggested at a height of 35-1/8" from the horizontal reference line). Mark a horizontal line approx. 12" from the lock edge of the door. Make sure the line is level.
- 5) **E** Draw two vertical lines, one at a distance of 1-1/2" and another at a distance of 4-1/2" from door edge on the top and bottom horizontal module lines.
- 6) **E** Punch the center point at vertical and horizontal lines intersect as shown. Drill pilot holes first. Drill (2) top holes and (2) bottom holes of 3/8" dia. through the door.

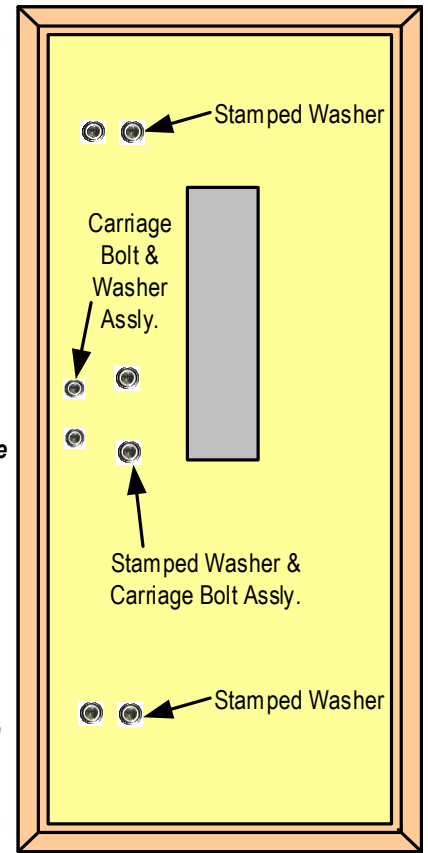

ROOM SIDE OF THE DOOR

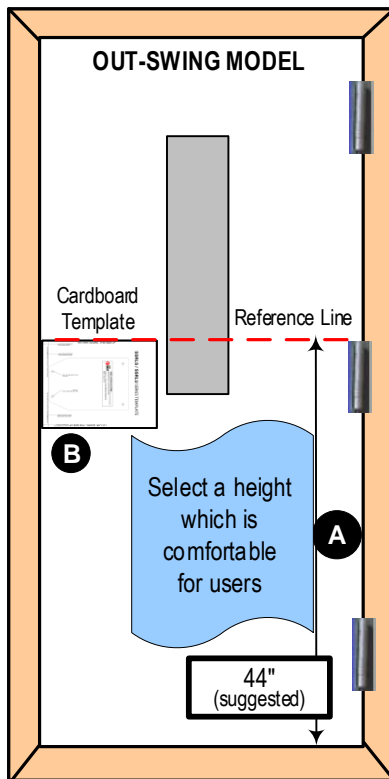

CORRIDOR SIDE OF THE DOOR

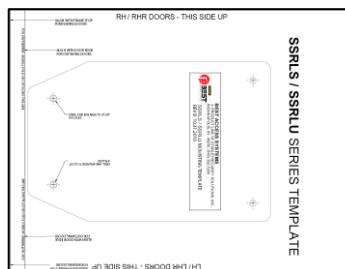

SSRLS / SSRLU
Cardboard Template

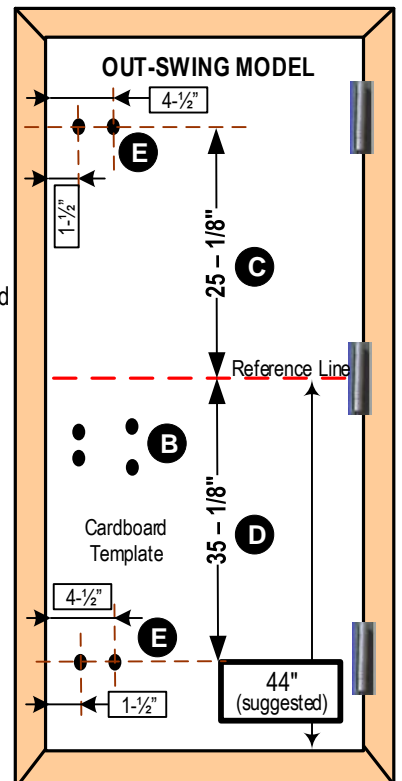

ROOM SIDE OF THE DOOR

IN-SWING MODEL

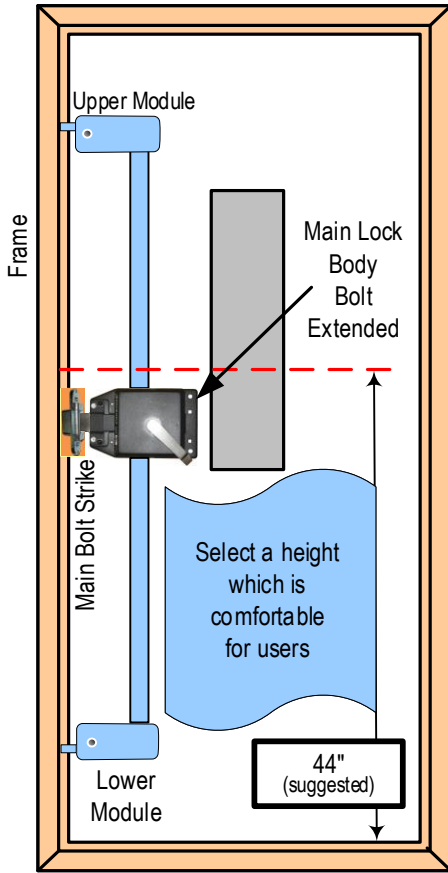

CORRIDOR SIDE OF THE DOOR

The locksets are handed. When unlocked, the lever should always point upward.

3- Point Horizontal Lock Installation

DOOR MARKING & DRILLING:

IMPORTANT: Make sure the door swings free and smooth before you begin the installation. Remove all old locks, exit devices, any slide bolts or other hardware & brackets. Make sure any exposed holes left from previous hardware are completely covered after installation.

Make any adjustments to make the door swing FREELY before you start marking and installing.

- 1) **A** Mark a horizontal reference line on the corridor side of the door, at a height of 44" from the bottom of the door (not floor). Extend the line to the hinge side of the door.
- 2) **B** Align the template with the horizontal reference line and the frame stop then tape it to the door. Please refer the cardboard template to mark and drill the holes. Drill (4) 3/8" through holes (TIP: Start with 1/8"). Make sure you drill level.
- 3) **C** Select a location for the height of the top module (suggested at a height of 25-1/8" from the horizontal reference line). Mark a horizontal line approx. 12" from the lock edge of the door. Make sure the line is level.
- 4) **D** Select a location for the height of the bottom module (suggested at a height of 35-1/8" from the horizontal reference line). Mark a horizontal line approx. 12" from the lock edge of the door. Make sure the line is level.
- 5) **E** Draw two vertical lines, one at a distance of 2-3/16" and another at a distance of 5-3/16" from frame stop on the top and bottom horizontal module lines.
- 6) **E** Punch the center point at vertical and horizontal lines intersect as shown. Drill pilot holes first. Drill (2) top holes and (2) bottom holes of 3/8" dia. through the door.

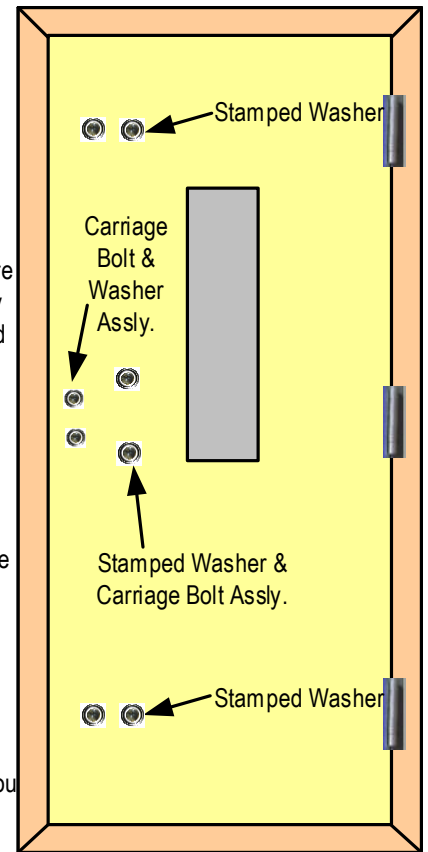

ROOM SIDE OF THE DOOR

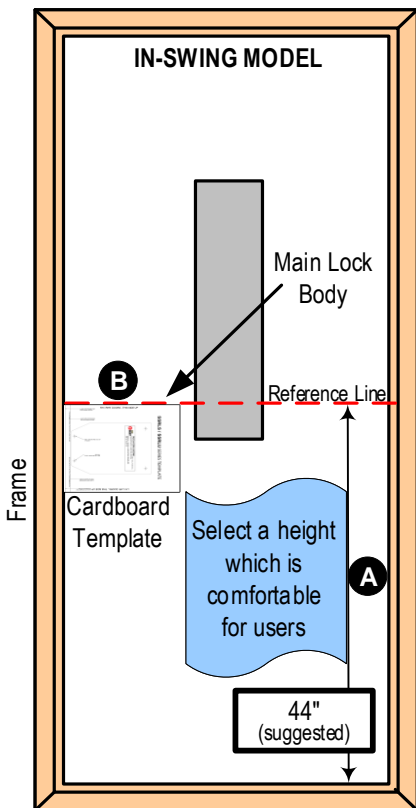

CORRIDOR SIDE OF THE DOOR

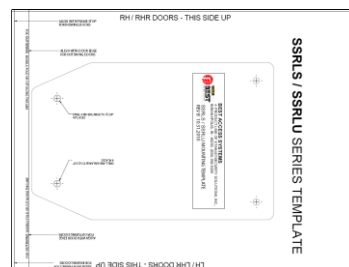

SSRLS / SSRLU
Cardboard Template

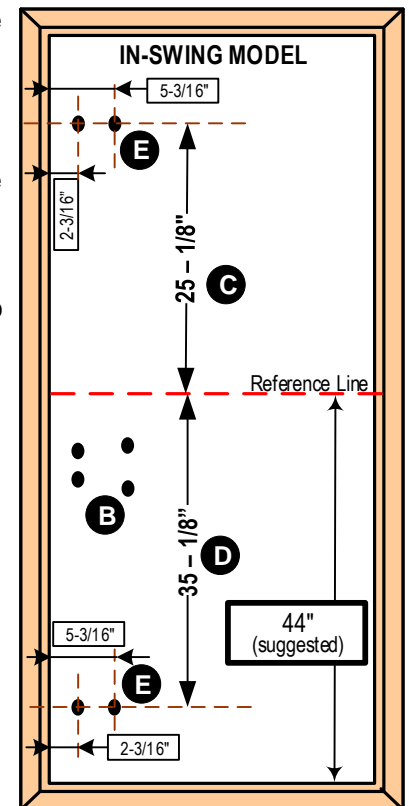

ROOM SIDE OF THE DOOR

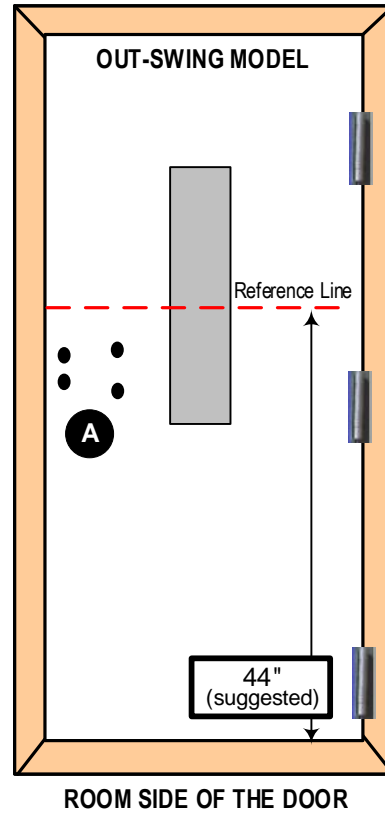
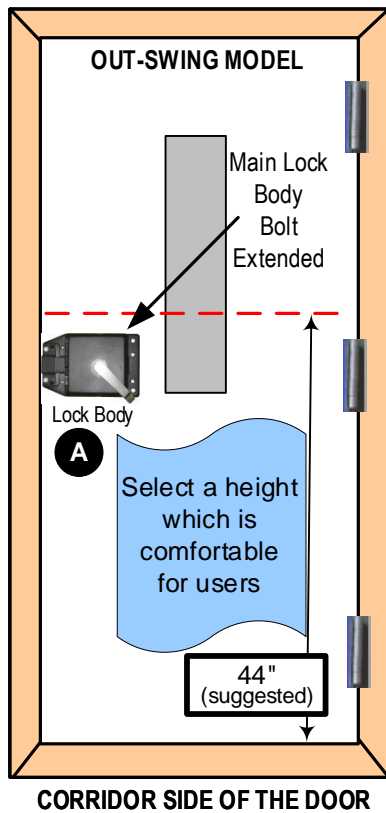

LOCK BODY INSTALLATION

- 1) **A** Align the mounting plate of the lock body with (4) drilled holes on the door. Install Fasteners as follows:
- 2) **B** **Lock Body Front Holes:** (2) 2- $\frac{3}{4}$ " long carriage bolts & washer Assly., k-lock nuts & acorn caps.

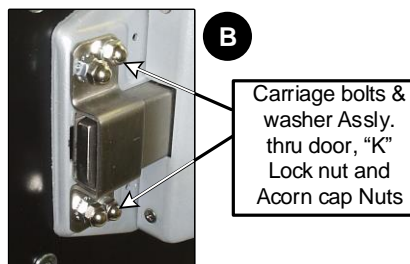

- 3) **C** **Lock Body Rear Holes:** (2) 2- $\frac{1}{2}$ " long carriage bolts, stamped washers, Flat Washers, k-lock nuts & acorn nuts.

Bolt extends when lever is rotated down

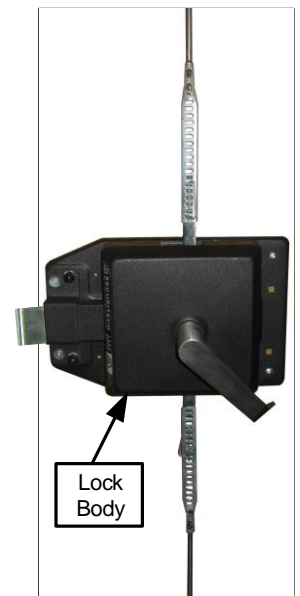
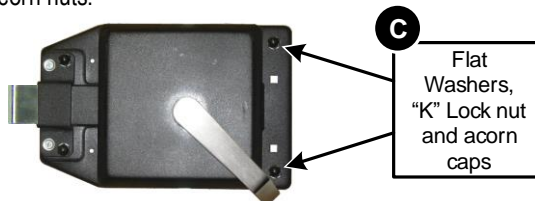

Important Note: Do not compress the door.

- 4) Rotate lever to make sure bolts extend and retract smoothly. Make sure the main bolt is extended before next step.

TOP MODULE INSTALLATION

- A** Use a level on the interior module and exterior thru-bolt plate to ensure module is level. Fasten module to door with (2) stamped washer and carriage bolts, from the exterior. Tighten 1/4"-20 K Lock Nut and then tighten 5 mm hex nut securely.
- B** Once level, secure in place with #14 self-drilling screw in recess as shown.
- C** Slide the channel (both overlapping segments of the channel) over the vertical rod. The crimped wide end of the channel should point towards the lock body. Slide the upper narrow segment of the channel down to reveal the vertical rod with loop. (**Note: Loop on the vertical rod should always face towards the hinge side of the door as shown**). Connect the top portion of the vertical rod with loop to the module by removing the bridge clip and placing the loop on the rod over the connecting arm pin. Then replace the bridge clip.
- D** Slide upper segment of the channel up to conceal the vertical rod and insert it into upper module. Approximately 1/2" of channel should rest on top module back plate. The crimped segment should fit snugly into the lock body housing.
- E** Slide the crimped segment of the channel up to reveal the slotted end of the rod. Hook the rod holder into the slots on the rod. Use the Quick Connect Pin to secure them together.
- F** Fasten both overlapping segments of the channels together with self-drilling screw on the side.
- G** Place cover over module and channel. Insert and secure Allen key threaded cap nut.

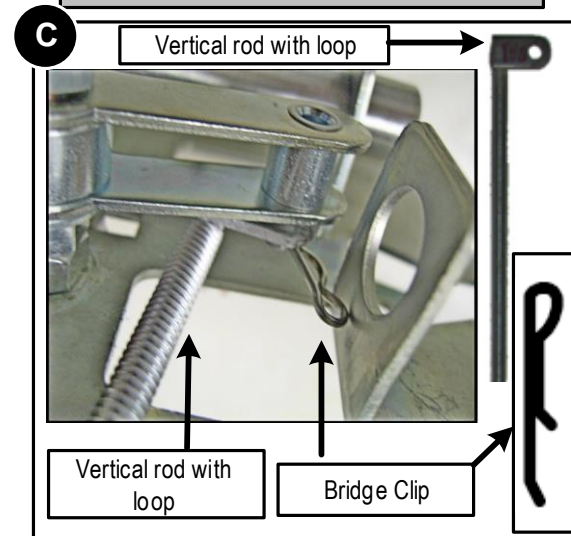
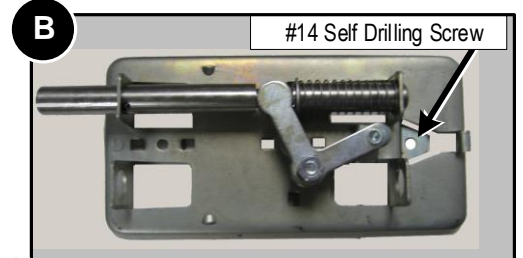
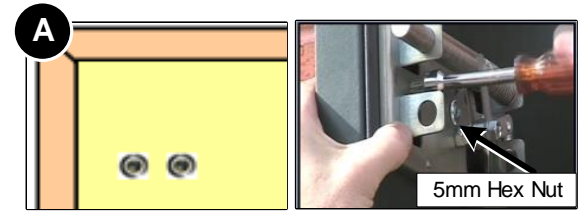

BOTTOM MODULE INSTALLATION

Repeat above steps for bottom module installation.

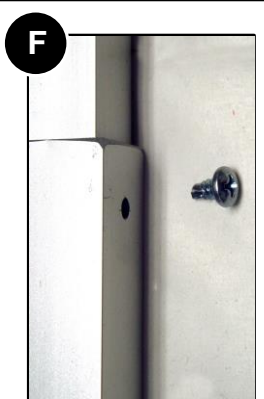
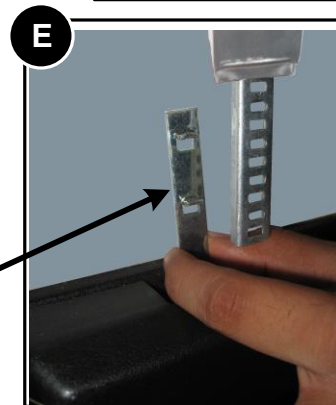
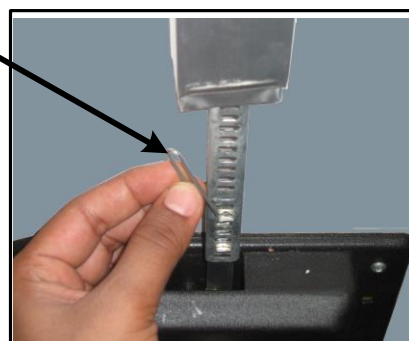
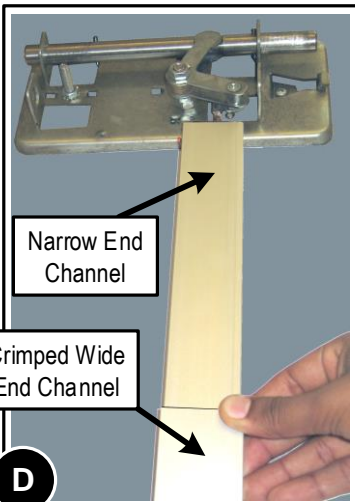
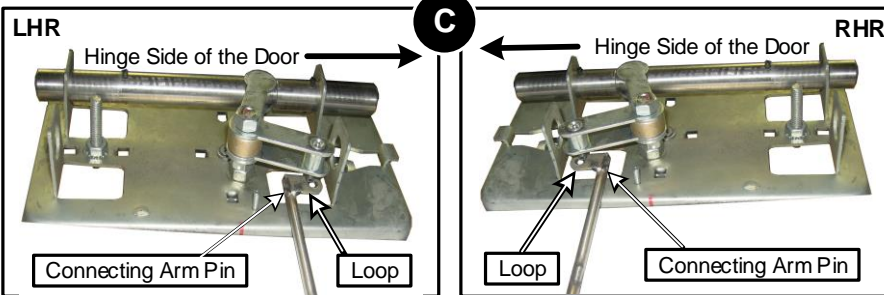

OUT-SWING:

ALUMINUM ANGLE INSTALLATION

- 1) Close the door first! Line up the edge of the aluminum angle with edge of the frame and strike opening **C** with main bolt as shown. Make sure Bolts are not rubbing and door can open easily.
- 2) Fasten the aluminum angle to the frame with #14 hex head self drilling screws.
- 3) Keeping the door pulled against the door stop, extend the bolts as much as possible. Trace the outline of the top and bottom bolts **A** & **B**.
- 4) Open the door and mark the centers of the top and bottom holes **D**. Center punch the point to be drilled. Drill a 1/8" pilot hole first and then enlarge to 3/4" and remove all burrs.

The dead bolt dia. is 5/8". A 3/4" hole, if drilled on center, should be sufficient. If you feel any rubbing, check to see which part of the bolt is rubbing in the hole and grind or enlarge that side of the hole.

- 5) Mount strike to the aluminum angle with 1/4 - 20 flat head Phillips screws and 1/4-20 K-Lock nuts. So, that roller faces you and is flush with aluminum angle as shown in **E**. Adjust so that main bolt operates smoothly and tighten the K-Lock nuts completely.

- 6) Check lock for the smooth operation.

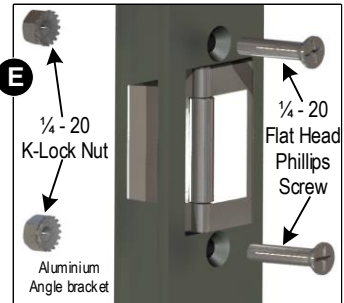
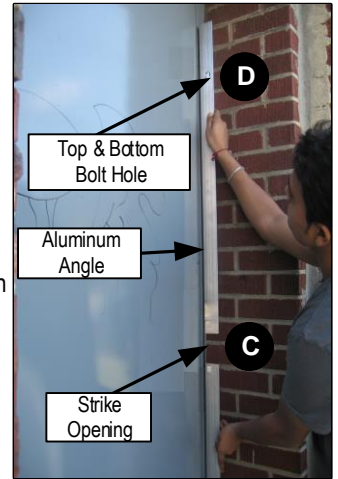
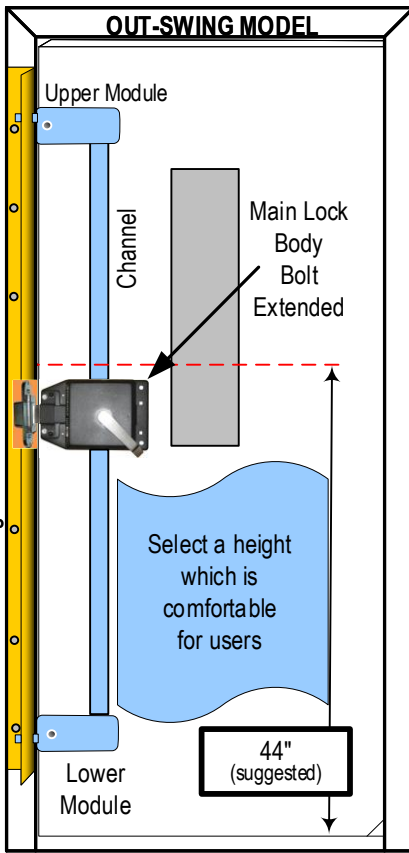

Inswing:

- 1) **A** Extend the bolts and draw center line for the bolt.
- 2) **B** Using a chisel, chop out the rectangle 1" x 1-3/4". Be sure the box can be placed at least 3/4" deep into stop.
- 3) **C** File the edges smooth.
- 4) **D** **Install the Main Deadbolt Strike**
Place the box strike into the hole. Mark and drill 1/8" pilot holes at the oval inner holes. Fasten the strike loosely with the 2 large self-drilling hex head screws. Adjust sideways as needed so the bolt moves freely before tightening the screws completely.
- 5) **E** After making the final strike position adjustment, insert the 2 small slot-hex head sheet metal screws into round outer holes to secure.

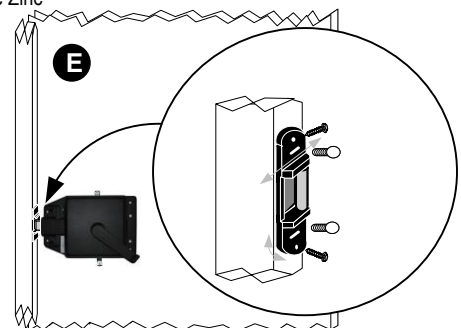
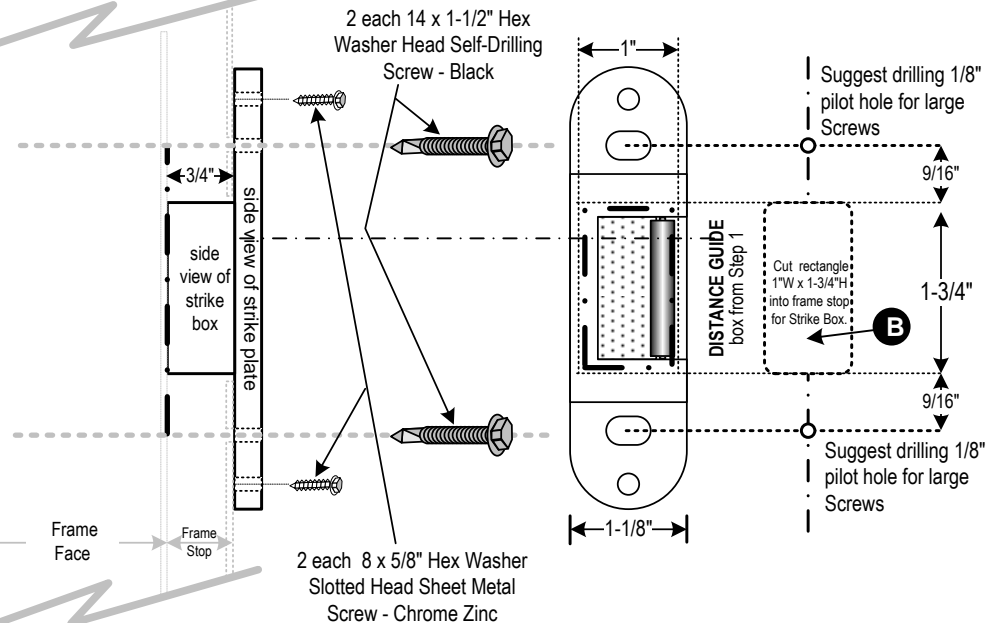

IN-SWING:

INSTALL MODULE STRIKE PLATE:

- A** Keeping the door pulled against the door stop, extend the bolts as much as possible. Trace the outline of the top and bottom deadbolts onto the frame.
- B** Open the door and mark the centers of the top and bottom deadbolt holes. Center punch point to be drilled. Drill 1/8" pilot hole first and then enlarge the deadbolt center hole 3/4" and remove all burrs.

The deadbolt dia. is 5/8". A 3/4" hole, if drilled on center, should be sufficient. If you feel any rubbing, check to see which part of the bolt is rubbing in the hole and grind or enlarge that side of the hole.

- C** Line up the module strike plate with center drilled hole. Mark the centers of the (2) holes for the top and bottom module strike plate. Drill 1/8" pilot holes first as shown.
- D** Fasten the top and bottom module strike plate with (4) #8 Flat Phillips thread cutting screws.
- E** Check lock for the smooth operation.

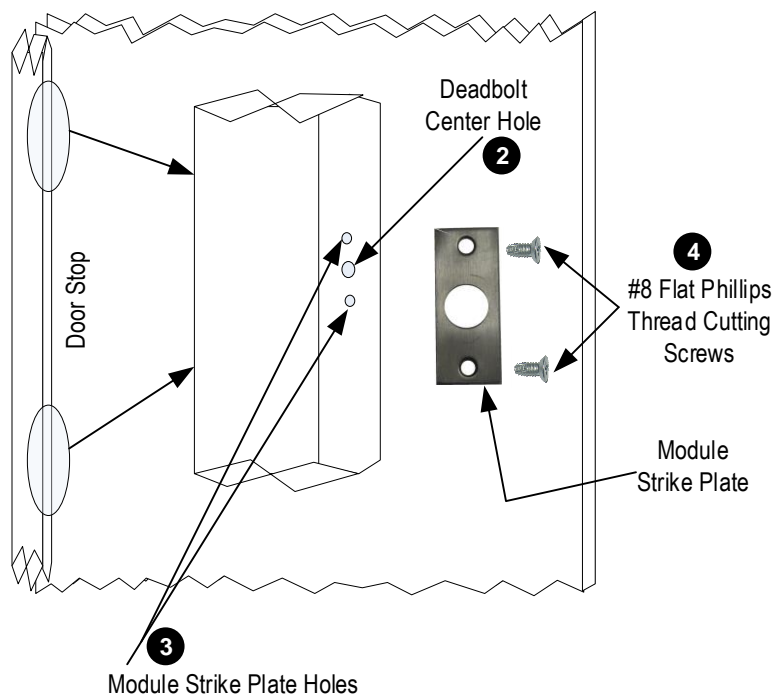

BEST ACCESS SYSTEMS

A division of dormakaba
Indianapolis, IN – 46250
(855) 365-2407