

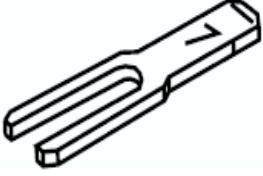

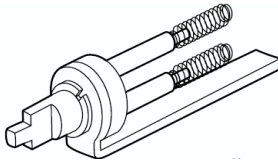

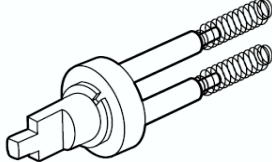





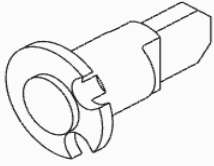

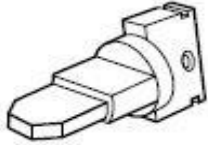

BEST Throw Members & Related Components

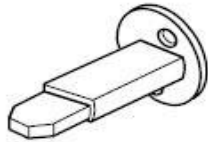
			
<p>1.) 9K/8K Standard Throw Member, p/n B54200 (Approx. 1.662" overall length)</p>	<p>2.) 9K Hotel (H) Throw Member, p/n A55697</p>	<p>3.) 9K Hotel (HJ) Throw Member, p/n A55696</p>	<p>4.) 6 Pin Spacer, p/n A06831</p>
			 <p style="text-align: center;">Replacement Kit</p>
<p>5.) 9K LFIC Throw Member for Schlage LFIC cores. P/n A81343</p>	<p>6.) 9K Sleeve for Schlage LFIC cores. P/n A81446</p>	<p>7.) 9K Washer for Schlage LFIC cores. P/n A81342</p>	<p>8.) 9K-SCHRC Schlage LFIC Throw Member Kit. P/n 1908227S</p>
			
<p>9.) 9K NON IC Throw Member for Sargent & Yale Cores. P/n B55709</p>	<p>10.) 9K NON IC Throw Member for Schlage, Corbin, KA, KD and OB Cores. P/n A55708</p>	<p>11.) 9K NON IC Throw Member for Medeco Cores. P/n A55712</p>	<p>12.) 9K Throw Member Support Ring for NON IC Cores. P/n A55713</p>
			
<p>13.) 9K Lever Handle Insert for NON IC Cores. P/n C55714</p>	<p>14.) 7AC Throw Member for Lever Adaptation. P/n A80405</p>	<p>15.) 7AC Throw Member for Knob Adaptation. P/n B80410 OBSOLETE (7KC Throw Member Possible Alternate).</p>	<p>16.) 7KC Standard Throw Member, p/n B56165 (Approx. 1.320" overall length)</p>

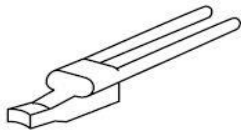
			
<p>17.) 7KC NON IC Throw Member, Ilco/Schlage Standard NON IC</p>	<p>18.) 7KC Lever Insert, NON IC. P/n A56170</p>	<p>19.) 6K Throw Member, Current, p/n 73125559S (Approx. 1.900" overall length)</p>	<p>20.) 6K Throw Member, 2nd Gen, Discontinued in 2009</p>

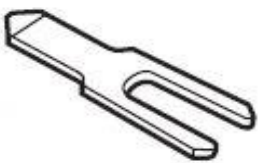
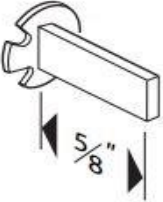
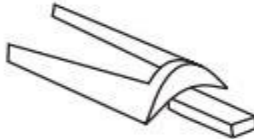
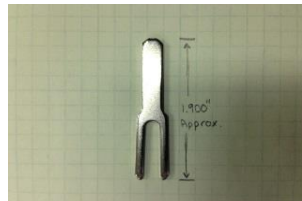
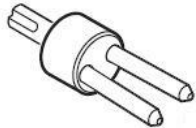
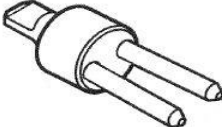
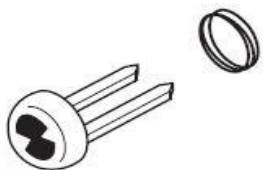
			
<p>22.) 6K Throw Member, 1st Gen, Discontinued</p>	<p>23.) 5K Throw Member, I/C, A, D & R functions. p/n 71923067S</p>	<p>24.) 5K NON IC Throw Member, D function. P/n 71923109S</p>	<p>25.) 5K NON IC Throw Member, A & R functions. P/n 71923025S</p>

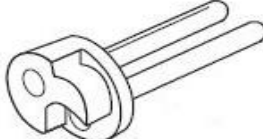
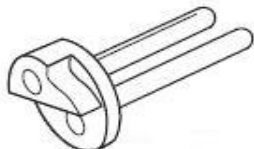
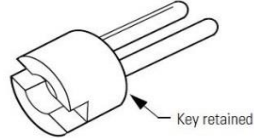
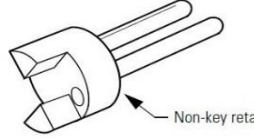
			
<p>26.) B Series Throw Member, (T) Key Retained. P/n A26177 (71488214S)</p>	<p>27.) B Series Throw Member, (L) Non-Key Retained. P/n A26185 (71488172S)</p>	<p>28.) B Series Throw Member for Old 71B, 81B and 91B. P/n A19463. OBSOLETE</p>	<p>29.) B Series Throw Member for Old 71B, 81B and 91B. P/n A19462. OBSOLETE</p>